

LONDON BOROUGH OF ENFIELD

PLANNING COMMITTEE

Date: 17 November 2020

Report of
Head of Planning

Contact Officer:
Andy Higham
David Gittens
Max Leonardo Tel No: 020 8132 3185

Ward:
Grange

Application Ref: 20/02895/FUL

Category: Full Application

LOCATION: 30A Raleigh Road Enfield EN2 6UB

PROPOSAL: Installation of door with Juliet balcony and rooflight.

Applicant Name & Address:

Cllr Claire Stewart
30A Raleigh Road
Enfield
EN2 6UB

Agent Name & Address:

Mr David Balkind
141 Faraday Road
Wimbledon
London
SW19 8PA

RECOMMENDATION:

That the Head of Development Management / Planning Decisions Manager be authorised to **GRANT** planning permission subject to the following conditions.

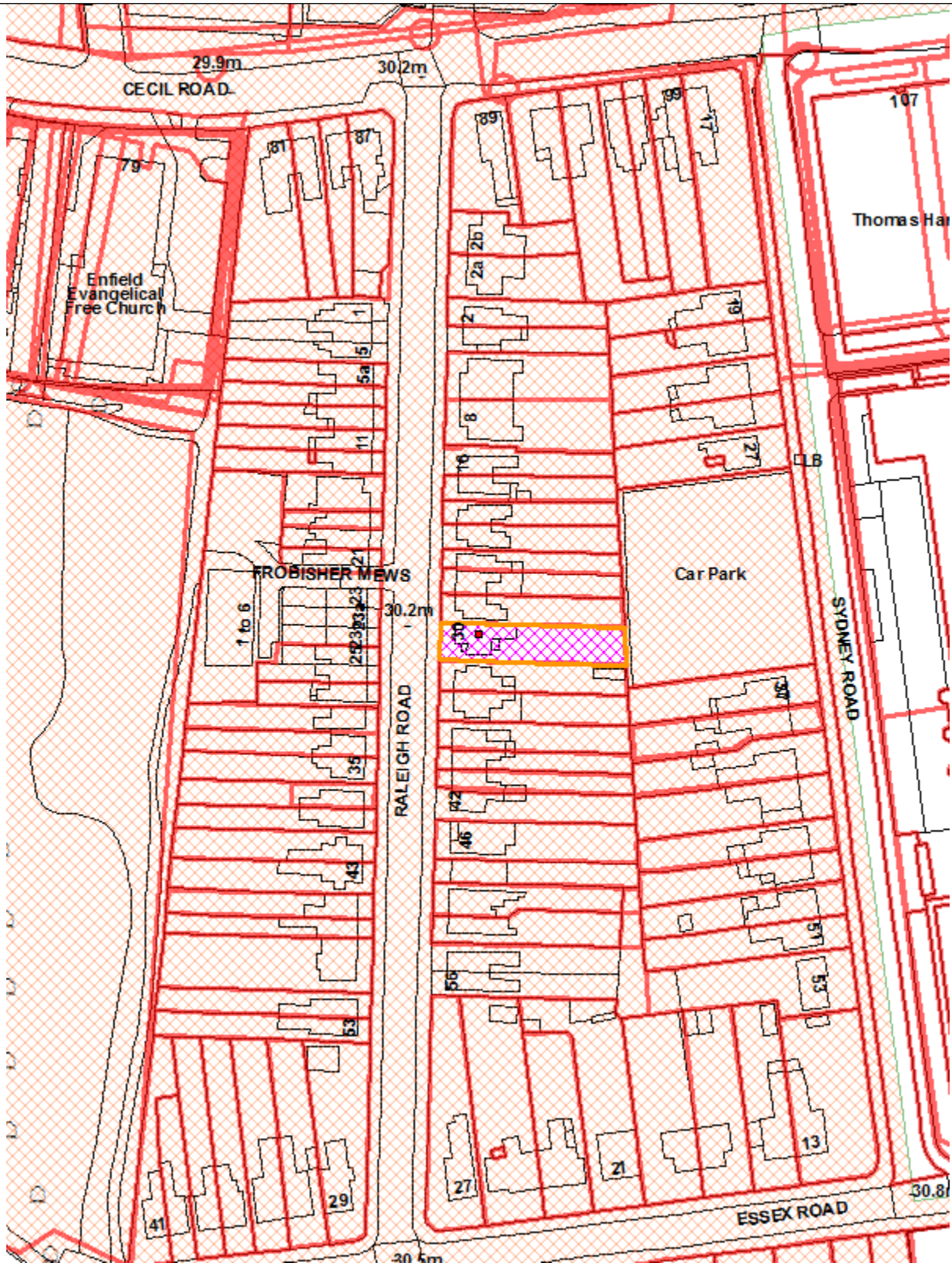

Reproduced by permission of Ordnance Survey on behalf of HMSO. ©Crown Copyright and database right 2013. All Rights Reserved. Ordnance Survey License number 100019820

Scale 1:1250



1. Note for Members:

- 1.1 A planning application of this nature would normally be determined under delegated authority. However, the applicant is a Councillor and, in accordance with the scheme of delegation, the application is reported to Planning Committee for determination.

2. Recommendation

- 2.1 That the Head of Development Management / the Planning Decisions Manager be authorised to **GRANT** planning permission subject to the following conditions:

1. The development to which this permission relates must be begun not later than the expiration of three years beginning with the date of the decision notice.

Reason: To comply with the provisions of S.51 of the Planning & Compulsory Purchase Act 2004.

2. The development hereby permitted shall be carried out in accordance with the approved plans as set out in the attached schedule which forms part of this notice.

Site Location Plan

EGA001 Existing First Floor Plan & Side & Rear Elevations

PGA001 A Proposed First Floor Plan & Side & Rear Elevations

PDE001 A Proposed Window and Door Sections

Reason: For the avoidance of doubt and in the interests of proper planning.

3. All new external works shall be carried out in materials that resemble, as closely as possible, in colour and texture those of the original building, unless otherwise specified in the approved plans.

Reason: To ensure a design which complies with Development Plan Policies.

3. Proposal

- 3.1. The applicant seeks planning permission to install a door and Juliet balcony in place of an existing rear first floor window together with a rooflight in the side facing roof slope of the existing two storey rear projection of the dwelling.

4. Site and Surroundings

- 4.1. The application property is the first floor flat in a two storey detached residential building on the east side of Raleigh Road. The immediate surroundings to the application site are residential in character.

- 4.2. The application property is located in the Enfield Town Conservation Area. It is not listed, nor is it located in the setting of one.

5. Relevant History

30A Raleigh Road

- 5.1. None.

30 Raleigh Road

- 5.2. TP/96/0539: Installation of replacement windows to existing property.

- Granted with Conditions.
- 25.07.1996

- 5.3. TP/71/1264: 2 FLATS

- Granted with Conditions.
- 10.11.1971

6. Consultations

Statutory and Non-Statutory Consultees

- 6.1. Enfield Town Conservation Area Group: No comment.

Public

- 6.2. Consultation letters dated 8 October and expiring 1 November were sent to seven neighbouring properties. In addition, notice was posted outside of the property from 12 October to 3 November while notice was also published in the local press (Enfield Independent) on 14 October.

- 6.3. No representations were received from the public regarding this application.

7. Relevant Policies

- 7.1. London Plan (2016)

Policy 7.4 Local Character

Policy 7.6 Architecture

Policy 7.8 Heritage Assets and Archaeology

- 7.2. London Plan (intend to Publish)

Following an Examination in Public into the submission version of the Plan and modifications, in December 2019 the Mayor published his Intend to Publish

London Plan. On 13 March 2020, the Secretary of State issued Directions to change a number of proposed policies.

In line with paragraph 48 of the NPPF, the weight attached to this Plan should reflect the stage of its preparation; the extent to which there are unresolved objections to relevant policies; and the degree of consistency of the relevant policies in the emerging Plan to the NPPF.

Whilst the published London Plan (2016) remains part of Enfield's Development Plan, given the advanced stage that the Intend to Publish version has reached, significant weight can be attached to it in the determination of planning applications (although there is greater uncertainty about those draft policies that are subject to the Secretary of State's Direction). The following policies are considered particularly relevant:

D4: Delivering good design
HC1 Heritage Conservation & growth

- 7.3. Core Strategy (2010)
CP 4 Housing Quality
CP 30 Maintaining and Improving the Quality of the Built and Open Environment
CP 31 Built and Landscape Heritage
- 7.4. Development Management Document (2014)
DMD 8 General Standards for New Residential Development
DMD 37 Achieving High Quality and Design-Led Development
DMD 44 Conserving and Enhancing Heritage Assets
- 7.5. Other Relevant Policy/Guidance
National Planning Policy Framework (NPPF)
National Planning Practice Guidance (NPPG)

8. Analysis

Relationship to the Surrounding Conservation Area

- 8.1. The proposed Juliet balcony would be situated in place of an existing rear facing first floor window in the rear elevation of the property. The door and balustrades of the Juliet balcony would be made of wood and black painted steel respectively, which are considered to be materials sympathetic to the appearance of the property in the Conservation Area. Although they would form a larger and more prominent feature in the rear elevation of the host building than the existing window, their appearance would have no impact on the heritage significance of the Conservation Area and would cause no harm to the character and appearance of the wider Enfield Town conservation area.
- 8.2. The proposed rooflight would be installed in a discreet location on the roof slope of the two storey rear projection of the building and would be of a conservation style. This means that the rooflight would have an appropriate profile and limited impact on the appearance of the host building. Again, it is considered this feature

would not cause harm to the character and appearance of the wider conservation area.

- 8.3. Hence, as the proposal as a whole would not cause harm to the character and appearance of the host property, surrounding area or wider conservation area, it would be fully in accordance with Policies, 7.4, 7.6 & 7.8 of the London Plan 2016, Policies D4 and HC1 of the Intend to Publish London Plan, CP 30 & CP 31 of the Core Strategy 2010 and Policies DMD 8, DMD 37 & DMD 44 of the Development Management Document 2014.

Neighbouring Amenity

- 8.4. The proposed Juliet balcony would face rearwards and overlook the existing garden of the property. This outlook would be no different from that associated with the existing window and it is noted, no representations have been received objecting to the proposal. Furthermore, the insertion of the rooflight which faces upwards, is well above internal floor level and although side facing, will not cause overlooking or a loss of privacy.
- 8.5. As the proposal does not create any additional bulk or mass to the building, it would also not result in any loss of daylight or sunlight to any of the neighbouring properties, nor would it impact on the outlook.
- 8.6. As a result, it is considered the proposal would be in accordance with the policy requirement that development maintains neighbouring residential amenities, as set out in Policy 7.6 of the London Plan 2016, CP 4 of the Enfield Core Strategy 2010 and DMD 8 of the Enfield Development Management Document 2014.

Revisions

- 8.7. The proposal description has been amended from the description that was consulted upon, as the initial description included reference to the replacement of two UPVC windows. As this would be like-for-like replacement of the windows, it does not fall within the definition of development requiring planning permission set out in s.55 of the Town and Country Planning Act 1990 (as amended). Consequently, reference to the replacement windows has been removed from the description of development. This change to the description is not material and does not require further consultation.

9. Conclusion

- 9.1. It is considered that the proposal would be of no detriment to neighbouring residential amenity and would not harm the character and appearance of the host property or wider conservation area and therefore fully complies with the development plan policies.

:

1.

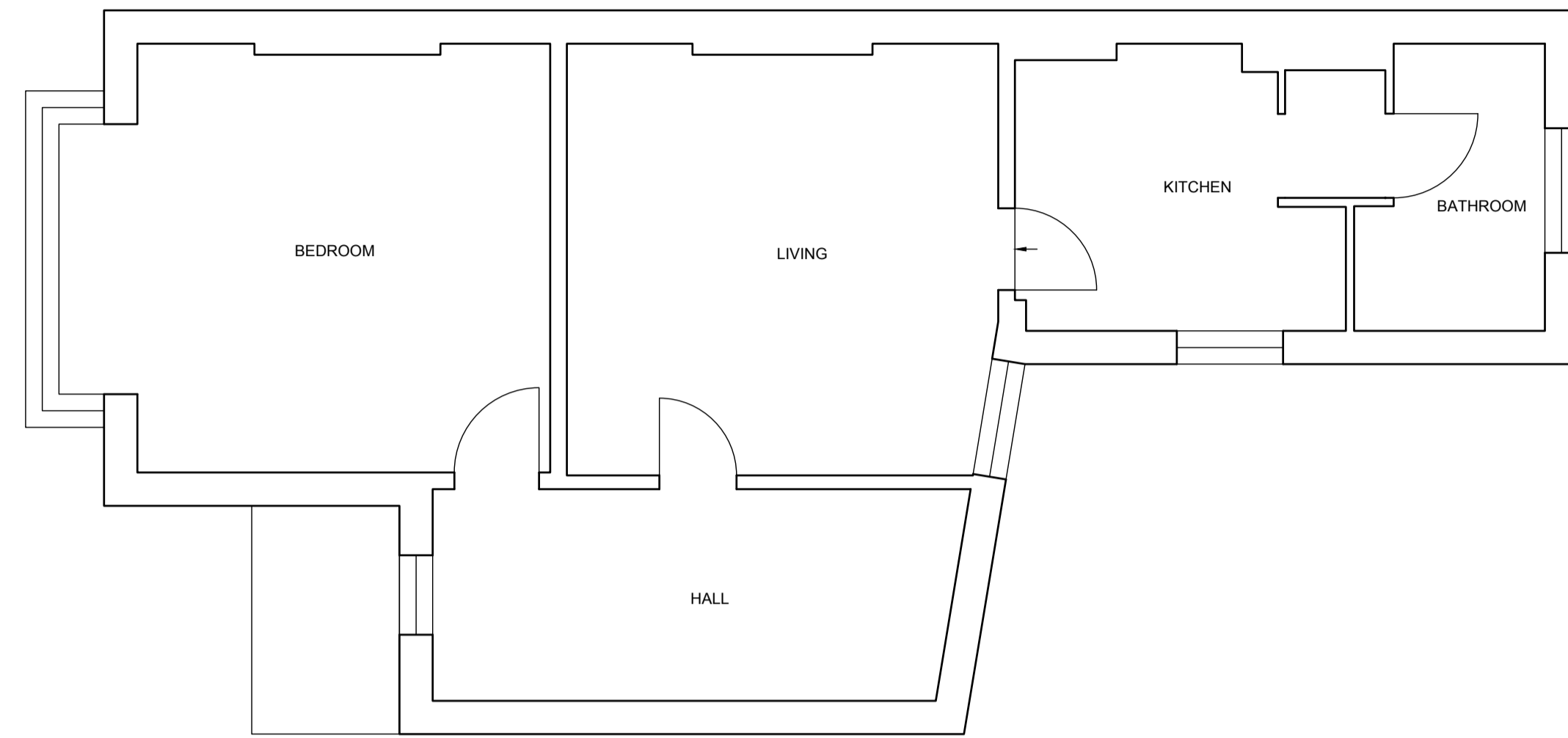

EXISTING FIRST PLAN

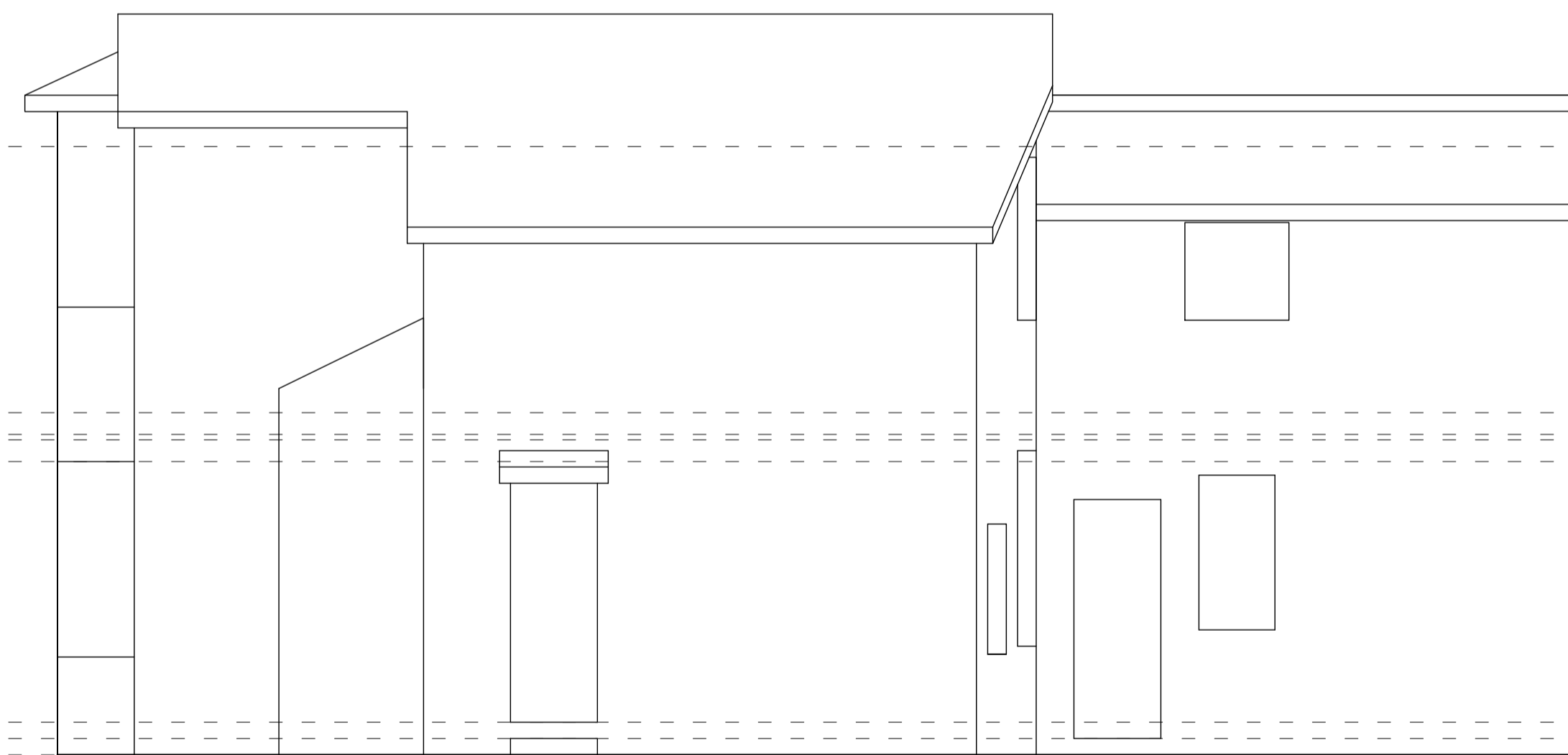

EXISTING FLANK ELEVATION

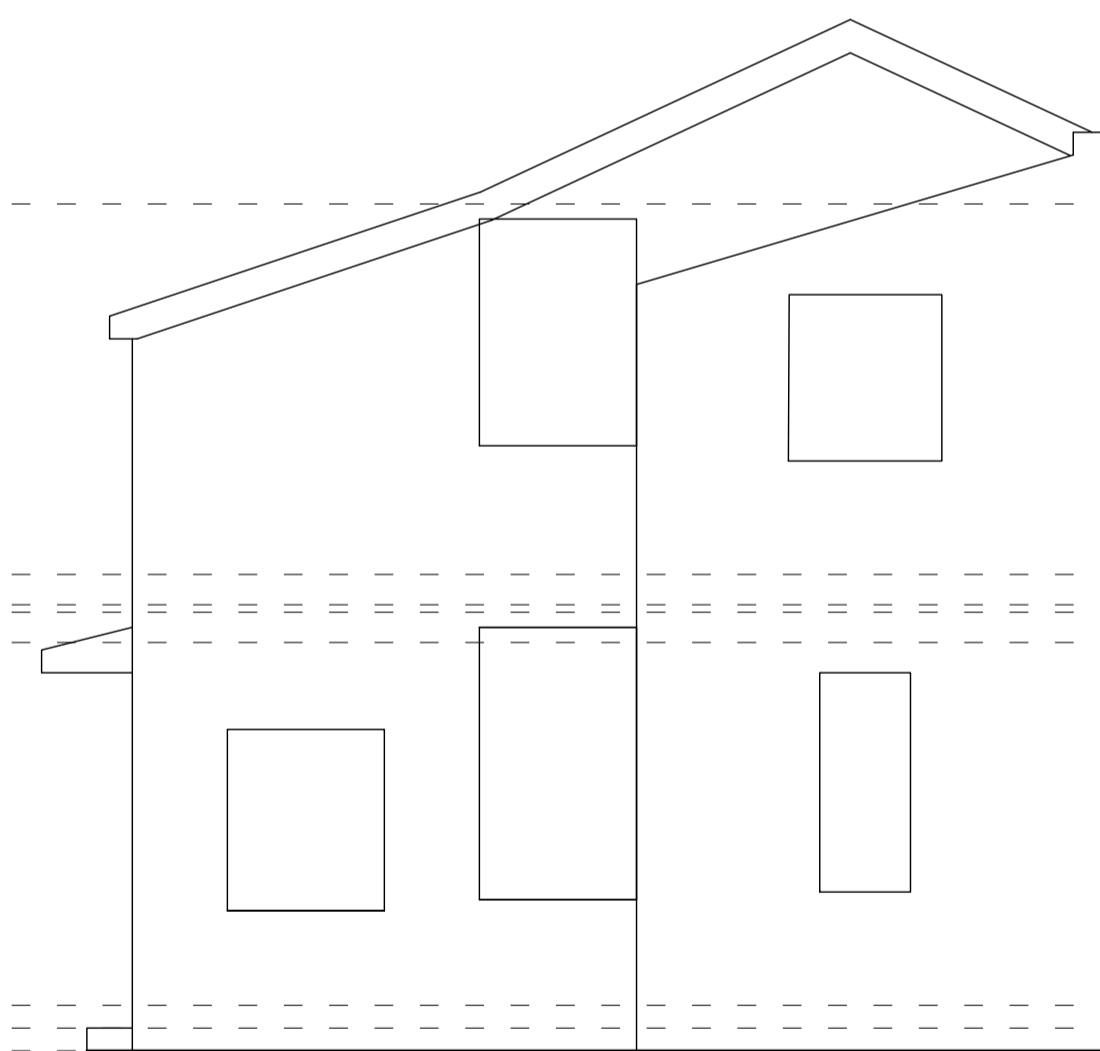

EXISTING REAR ELEVATION

GENERAL NOTES

1. THE CONTRACTOR MUST CHECK ALL DIMENSIONS ON SITE BEFORE COMMENCING WORK
2. ANY DISCREPANCIES MUST BE IMMEDIATELY BROUGHT TO THE ATTENTION OF THE DESIGNER
3. ALL WORK MUST CONFORM TO CURRENT BUILDING REGULATIONS, BRITISH STANDARDS & CODES OF PRACTICE AND NHBC STANDARDS
4. THESE DRAWINGS ARE TO BE READ IN CONJUNCTION WITH ALL RELEVANT DESIGNER, ENGINEER OR SPECIALIST DRAWINGS AND SPECIFICATIONS
5. ALL DIMENSIONS ARE IN MILLIMETERS UNLESS STATED OTHERWISE
6. ALL MATERIALS ARE TO BE USED AND INSTALLED IN STRICT COMPLIANCE WITH THE RELEVANT MANUFACTURER'S RECOMMENDATIONS
7. THE CONTRACTOR IS RESPONSIBLE FOR PROVIDING ALL NECESSARY TEMPORARY SUPPORT TO THE BUILDING AND ANY ADJACENT STRUCTURES
8. ALL CONSTRUCTION MUST BE BUILT WITHIN THE ACTUAL PROPERTY BOUNDARIES UNLESS PARTY WALL AGREEMENT ALLOWS OTHERWISE

HATCHLINE LEGEND		DRAINAGE ABBREVIATIONS	
	concrete		demolish
	brickwork		above/beyond
	blockwork		boundary
			drain
			insulation/ stud partition
			mh = manhole
			ic = inspection chamber
			re = rodding eye
			g = gully
			svp = soil vent pipe
			rwp = rain water pipe
			ss = stub stack
			rainwater drainage to contractor design
			electrical layout to client design

REVISION	DESCRIPTION	DATE

DRAW+PLAN

T: 0800 689 0101
 E: info@drawandplan.com
 W: www.drawandplan.com

Location
**30A RALEIGH ROAD
 ENFIELD
 EN2 6UB**

Drawing title
GENERAL ARRANGEMENT

Date	Scale	
29/07/2020	1:50@A1	
Job no.	Dwg no.	Revision
20060	EGA001	-

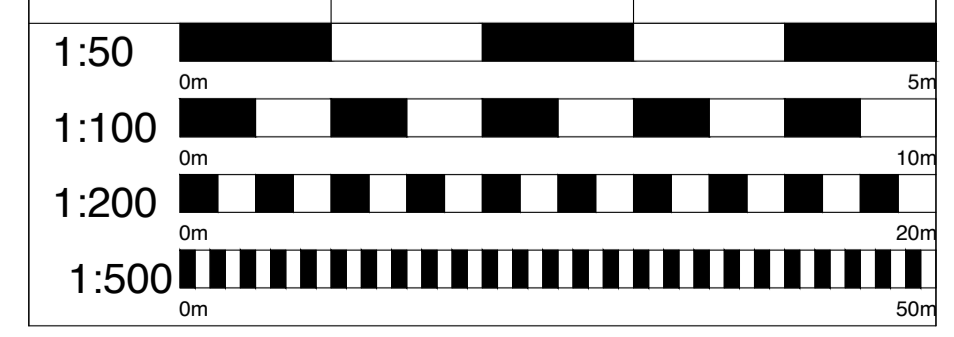

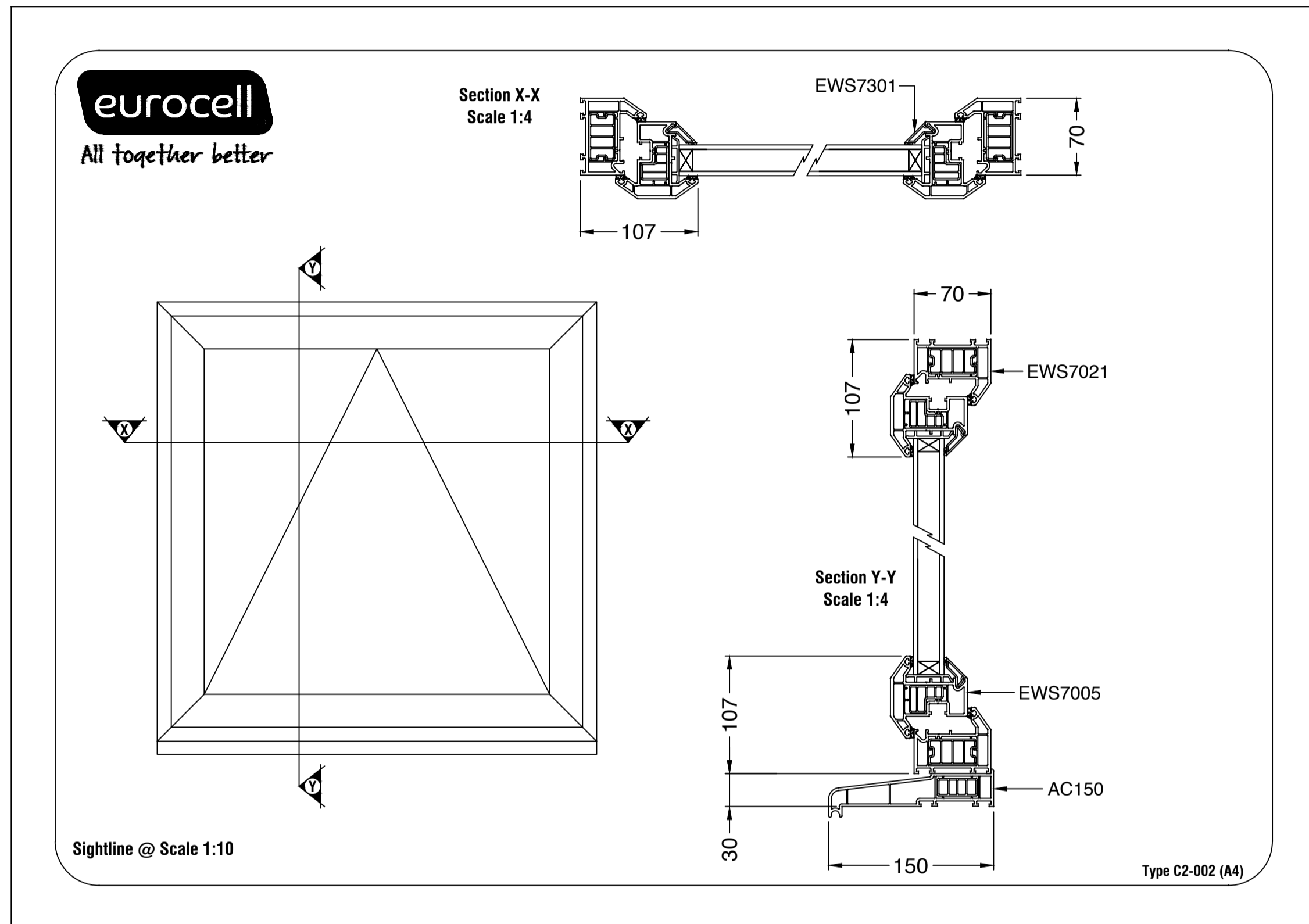

WINDOW DETAILS
SCALE 1:4

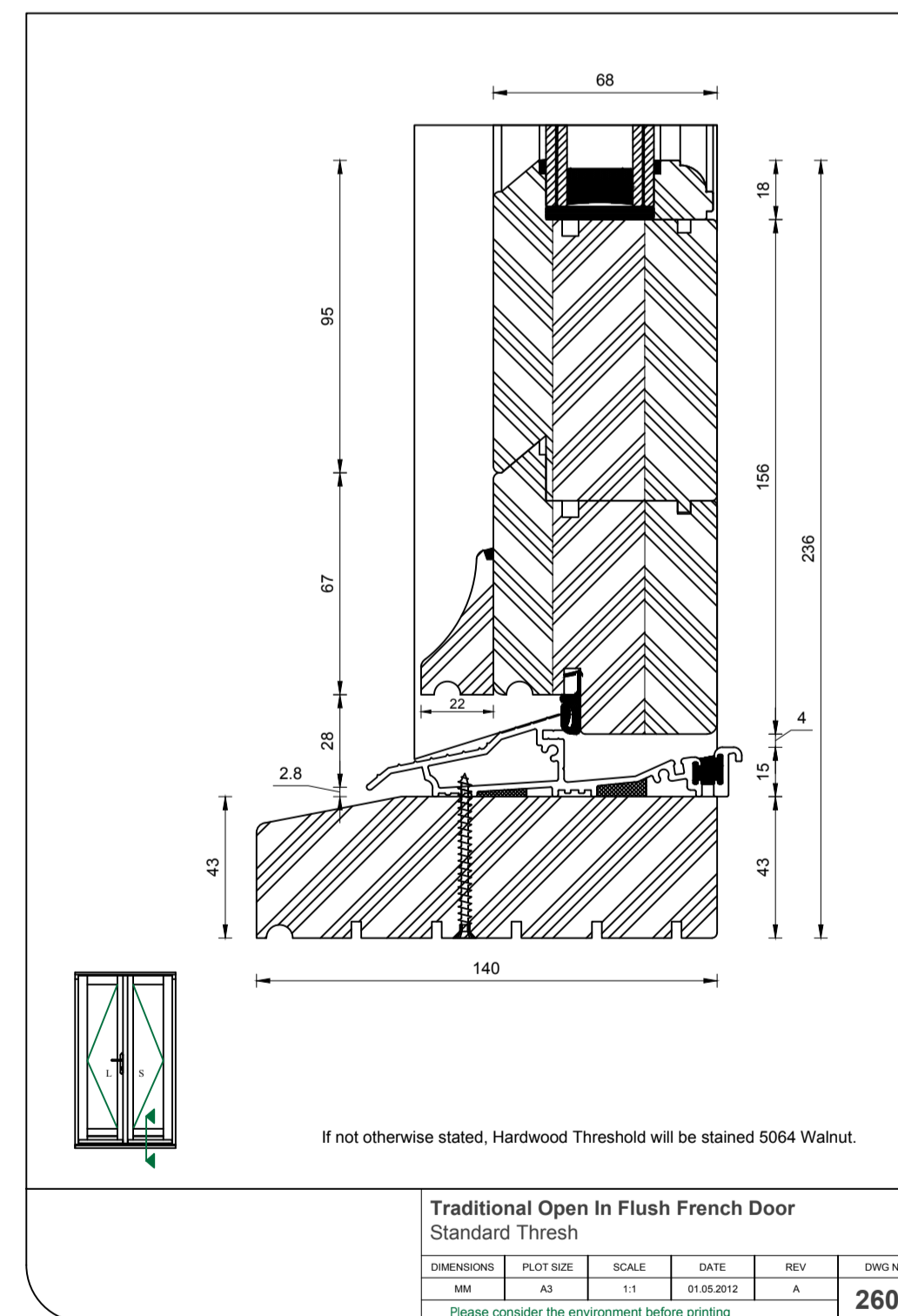
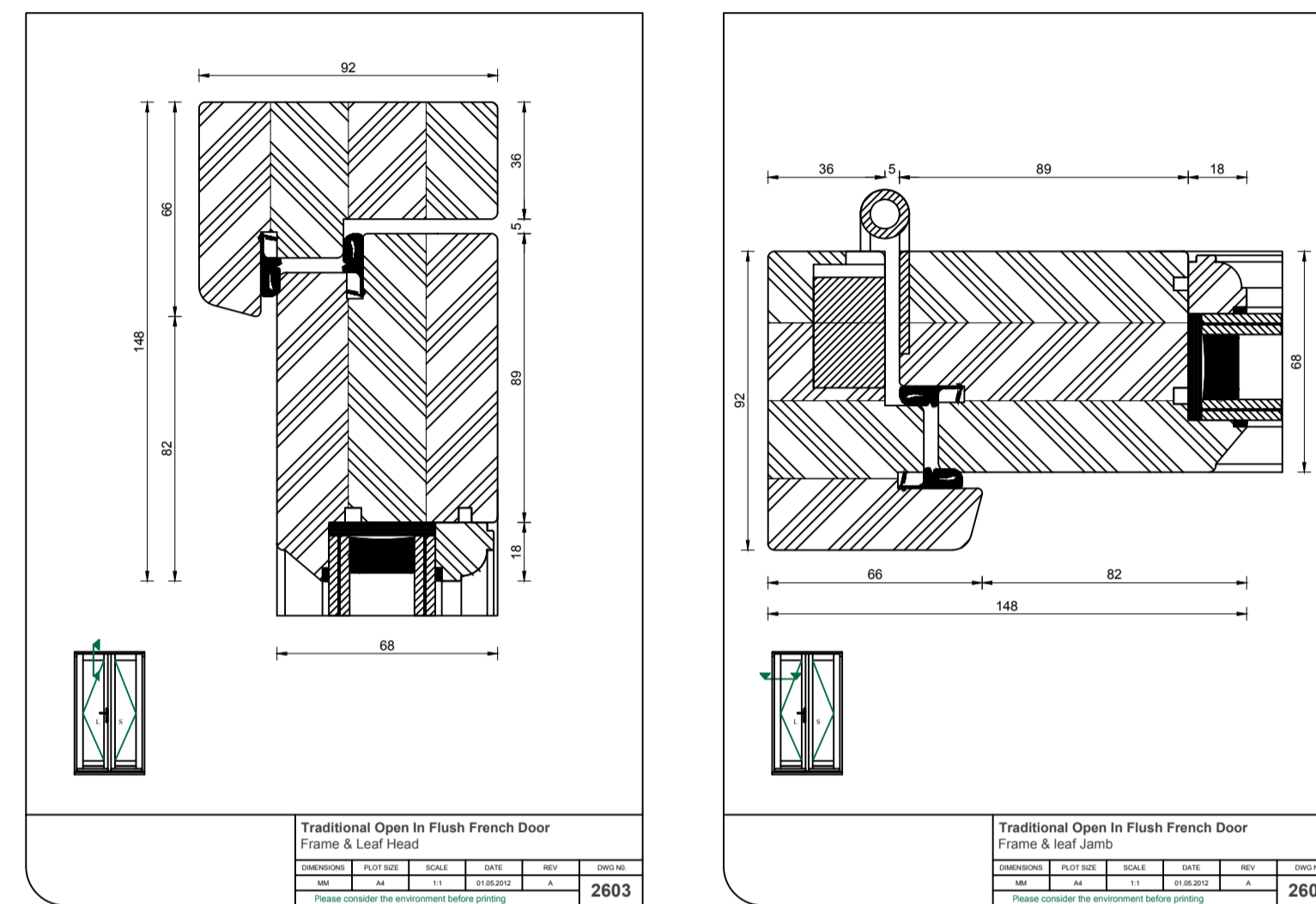

DOOR DETAILS
SCALE 1:2

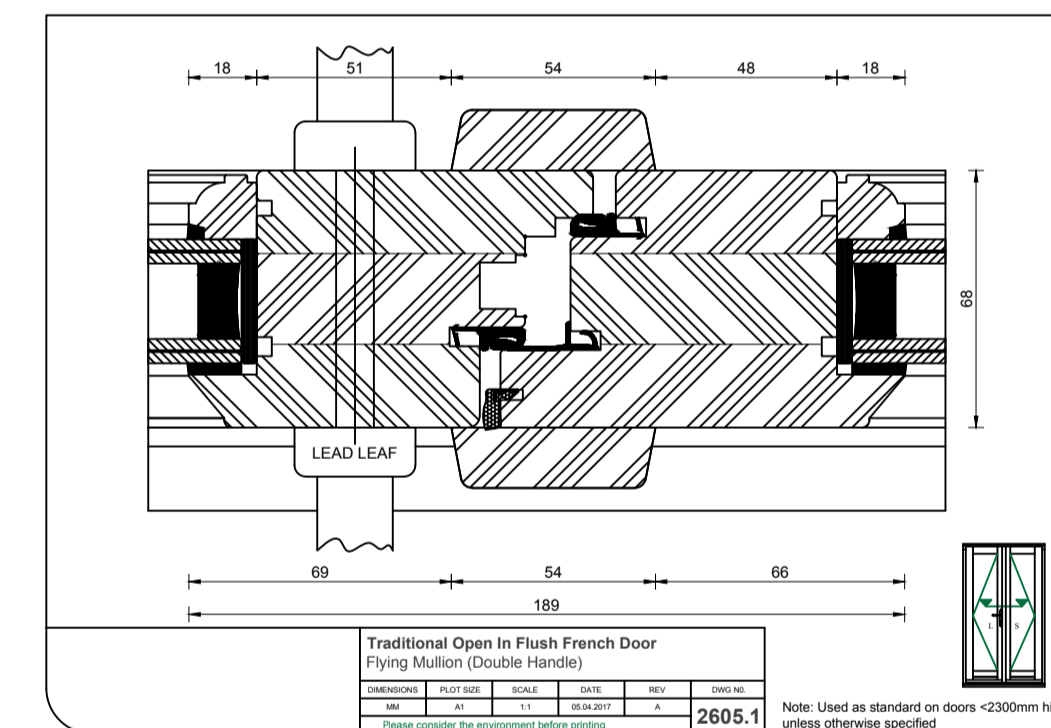

GENERAL NOTES

1. THE CONTRACTOR MUST CHECK ALL DIMENSIONS ON SITE BEFORE COMMENCING WORK
2. ANY DISCREPANCIES MUST BE IMMEDIATELY BROUGHT TO THE ATTENTION OF THE DESIGNER
3. ALL WORK MUST CONFORM TO CURRENT BUILDING REGULATIONS, BRITISH STANDARDS & CODES OF PRACTICE AND NHBC STANDARDS
4. THESE DRAWINGS ARE TO BE READ IN CONJUNCTION WITH ALL RELEVANT DESIGNER, ENGINEER OR SPECIALIST DRAWINGS AND SPECIFICATIONS
5. ALL DIMENSIONS ARE IN MILLIMETERS UNLESS STATED OTHERWISE
6. ALL MATERIALS ARE TO BE USED AND INSTALLED IN STRICT COMPLIANCE WITH THE RELEVANT MANUFACTURER'S RECOMMENDATIONS
7. THE CONTRACTOR IS RESPONSIBLE FOR PROVIDING ALL NECESSARY TEMPORARY SUPPORT TO THE BUILDING AND ANY ADJACENT STRUCTURES
8. ALL CONSTRUCTION MUST BE BUILT WITHIN THE ACTUAL PROPERTY BOUNDARIES UNLESS PARTY WALL AGREEMENT ALLOWS OTHERWISE

HATCHLINE LEGEND		DRAINAGE ABBREVIATIONS	
	concrete		demolish
	brickwork		mh = manhole
	blockwork		ic = inspection chamber
	above/beyond		re = rodding eye
	boundary		g = gully
	drain		svp = soil vent pipe
	insulation/ stud partition		rwp = rain water pipe
			ss = stub stack
			rainwater drainage to contractor design electrical layout to client design

REVISION	DESCRIPTION	DATE

DRAW+PLAN

T: 0800 689 0101
E: info@drawandplan.com
W: www.drawandplan.com

Location

30A RALEIGH ROAD
ENFIELD
EN2 6UB

Drawing title

TYPICAL DETAIL DRAWINGS

Date

23/10/2020

Scale

NTS@A1

Job no.

20060

Dwg no.

PDE001

Revision

A

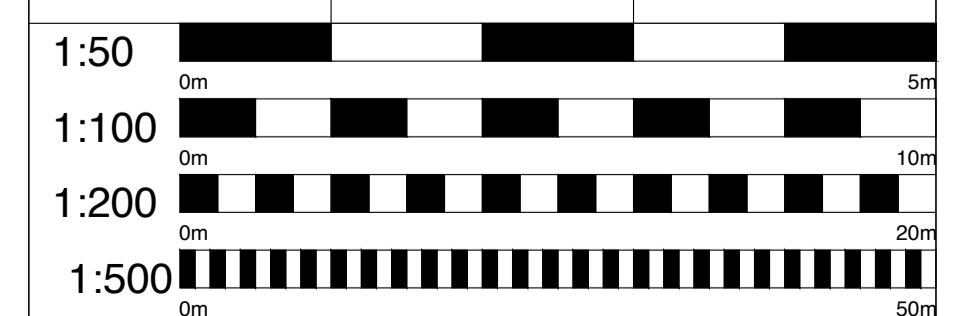

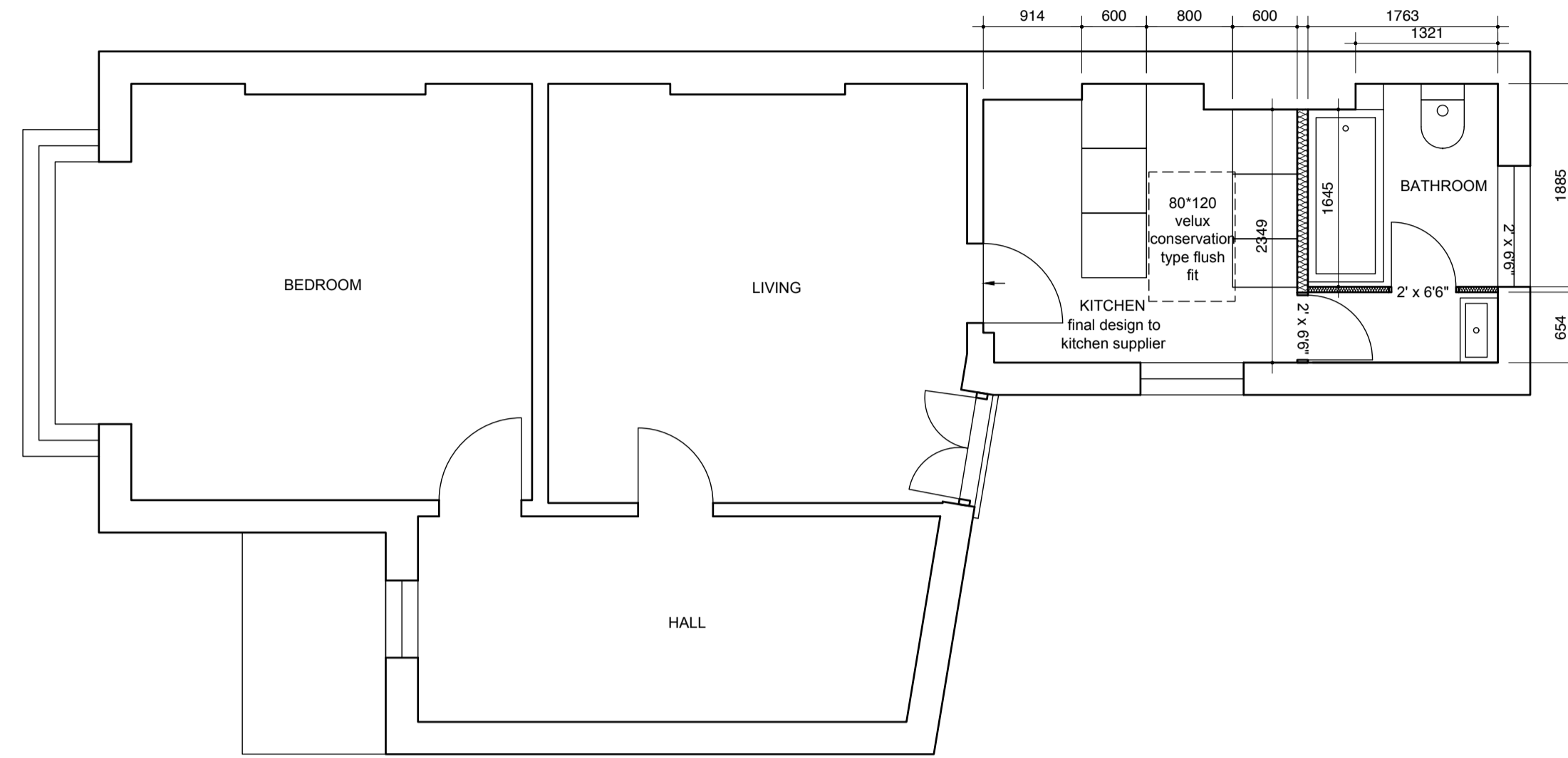

PROPOSED FIRST PLAN

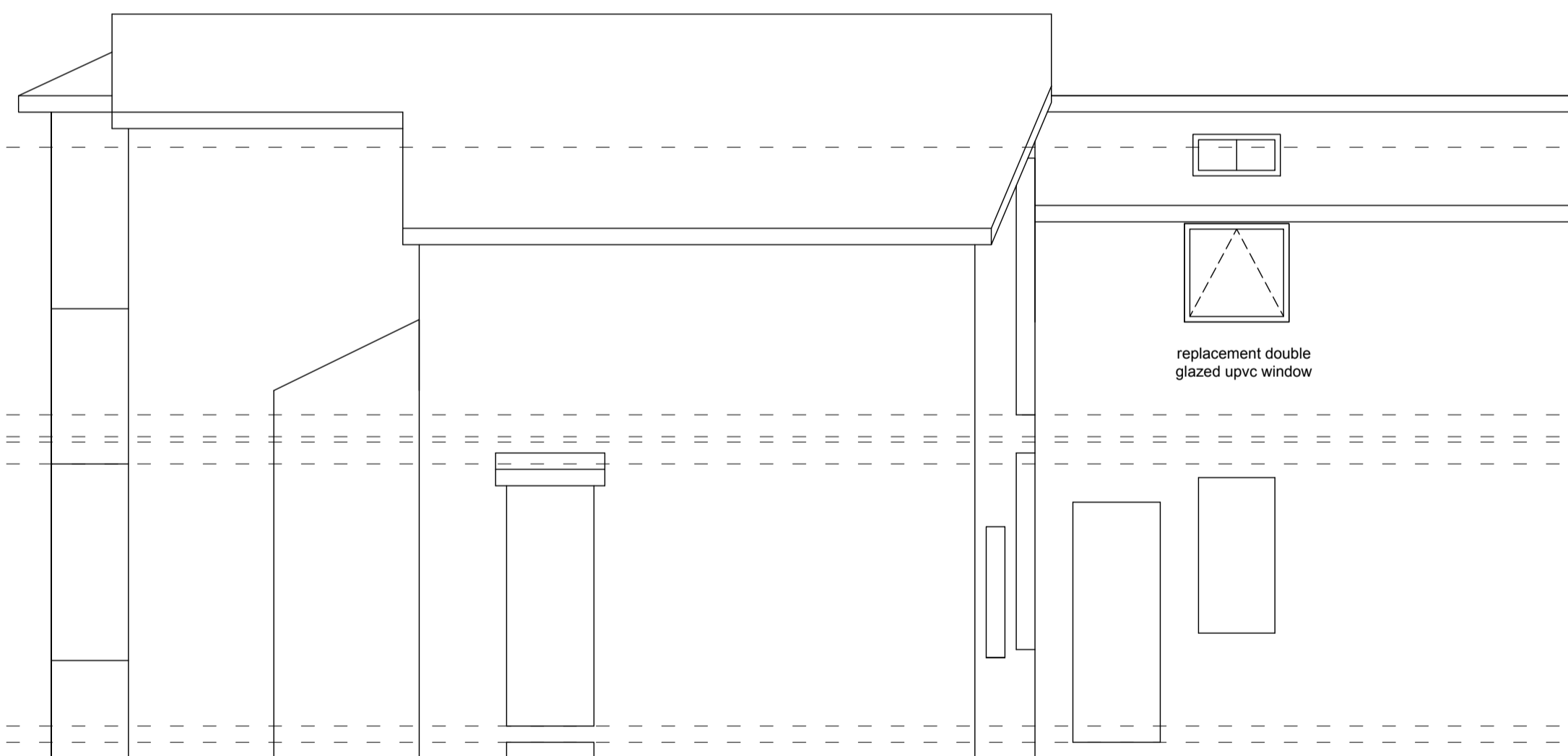

PROPOSED FLANK ELEVATION

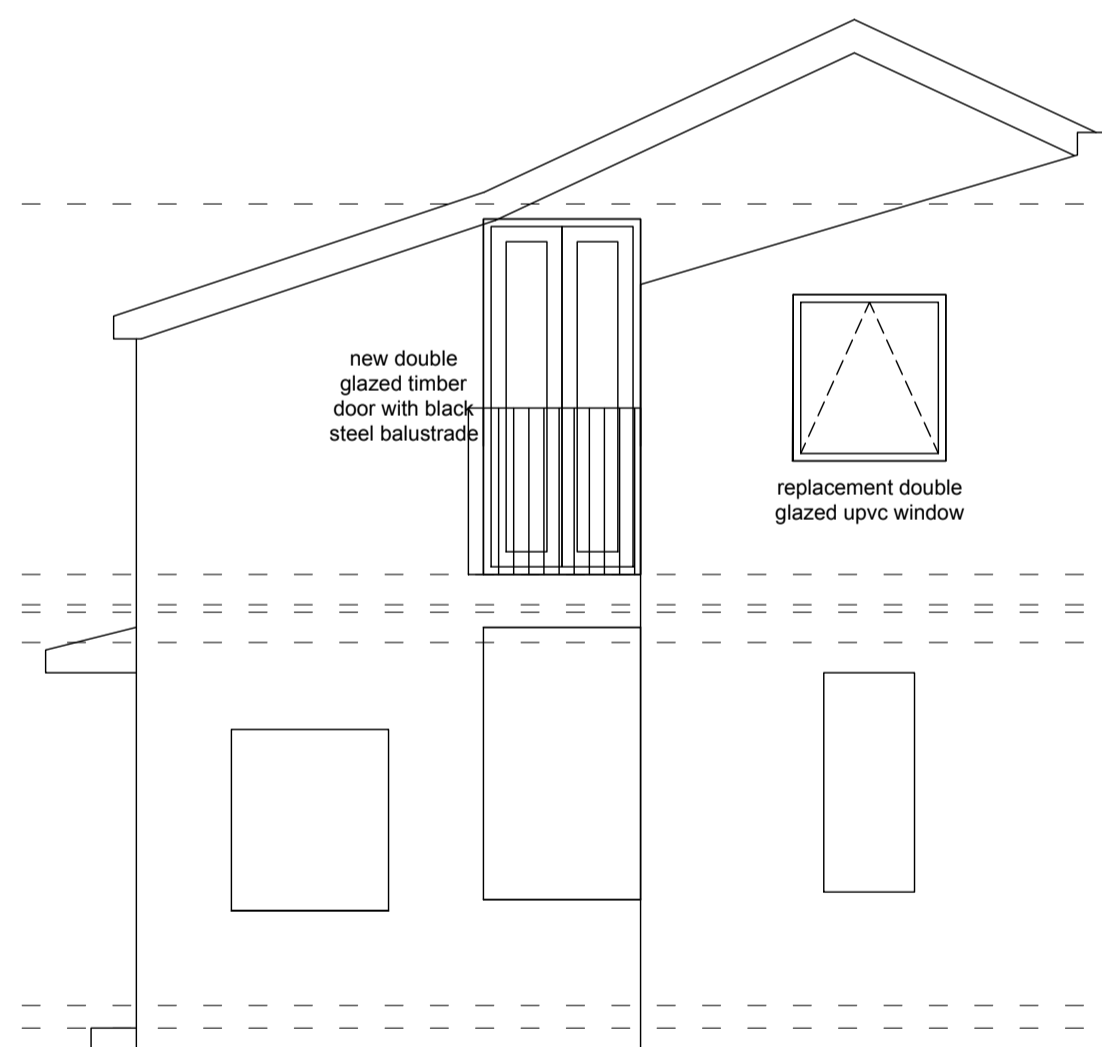

PROPOSED REAR ELEVATION

GENERAL NOTES

1. THE CONTRACTOR MUST CHECK ALL DIMENSIONS ON SITE BEFORE COMMENCING WORK
2. ANY DISCREPANCIES MUST BE IMMEDIATELY BROUGHT TO THE ATTENTION OF THE DESIGNER
3. ALL WORK MUST CONFORM TO CURRENT BUILDING REGULATIONS, BRITISH STANDARDS & CODES OF PRACTICE AND NHBC STANDARDS
4. THESE DRAWINGS ARE TO BE READ IN CONJUNCTION WITH ALL RELEVANT DESIGNER, ENGINEER OR SPECIALIST DRAWINGS AND SPECIFICATIONS
5. ALL DIMENSIONS ARE IN MILLIMETERS UNLESS STATED OTHERWISE
6. ALL MATERIALS ARE TO BE USED AND INSTALLED IN STRICT COMPLIANCE WITH THE RELEVANT MANUFACTURER'S RECOMMENDATIONS
7. THE CONTRACTOR IS RESPONSIBLE FOR PROVIDING ALL NECESSARY TEMPORARY SUPPORT TO THE BUILDING AND ANY ADJACENT STRUCTURES
8. ALL CONSTRUCTION MUST BE BUILT WITHIN THE ACTUAL PROPERTY BOUNDARIES UNLESS PARTY WALL AGREEMENT ALLOWS OTHERWISE

HATCHLINE LEGEND		DRAINAGE ABBREVIATIONS	
	concrete		demolish
	brickwork		above/beyond
	blockwork		boundary
			drain
			insulation/ stud partition
			mh = manhole
			ic = inspection chamber
			re = rodding eye
			g = gully
			svp = soil vent pipe
			rwp = rain water pipe
			ss = stub stack
			rainwater drainage to contractor design electrical layout to client design

REVISION	DESCRIPTION	DATE
----------	-------------	------

DRAW+PLAN

T: 0800 689 0101
E: info@drawandplan.com
W: www.drawandplan.com

Location
**30A RALEIGH ROAD
ENFIELD
EN2 6UB**

Drawing title
GENERAL ARRANGEMENT

Date	Scale
23/10/2020	1:50@A1

Job no.	Dwg no.	Revision
20060	PGA001	A

